



US
Material Handler | F-Series

MHL 350



215 hp (160kW) (Diesel)
132 kW (Electric)



max. 78,264 lbs



max. 52'5"



FUCHS[®]
A TEREX BRAND

TECHNICAL DATA

OPERATING WEIGHT WITHOUT ATTACHMENTS

MHL350 F	72,752–78,264 lbs
MHL350 F FQC	73,414–78,264 lbs

DIESEL ENGINE

	U.S. Tier 4 / EU Stage V	U.S. Tier 3 / EU Stage IIIA *
Manufacturer and model	Deutz TCD 6.1 L6	Deutz TCD2013 L6
Design	6-cylinder in-line engine	6-cylinder in-line engine
Functionality	4-stroke engine, direct common-rail fuel injection, turbocharger with charge air intercooling, controlled exhaust gas recirculation, diesel particle filter with a continuously regenerating system and SCR catalytic converter	4-stroke engine, direct common-rail fuel injection, turbocharger with charge air intercooling
Engine power	215hp (160 kW)	198 hp (148 kW)
Rated speed	2,000 min ⁻¹	2,000 min ⁻¹
Displacement	372 cui	439 cui
Cooling system	Water / charge air cooling with temperature-controlled fan speed	Water / charge air cooling with temperature-controlled fan speed
Exhaust emission standard	U.S. Tier 4 / EU Stage V	U.S. Tier 3 / EU Stage IIIA *
Fuel tank	83 gal Diesel	83 gal Diesel
DEF / Urea tank	8.5 gal AdBlue	■

ELECTRIC MOTOR

Power	132 kW
Total connected load	170 kW
Motor start	Via soft start
Optional cable reel	Up to 164 ft (other lengths on request)

ELECTRICAL SYSTEM

Alternator	28 V / 100 A
Operating voltage	24 V
Battery	2 × 12 V / 110 Ah / 760 A (as per EN)
Lighting system	2 × LED floodlights at the front of the machine, rear parking lights and indicator lights
Option	13 kW or 20 kW DC generator with control and insulation monitoring

TRAVEL DRIVE

Hydrostatic drive through infinitely variable axial piston motor with directly mounted travel brake valves, 2-gear transmission, all-wheel drive

	MHL350 F	MHL355 F
Travel speed 1st Gear	max. 3.1 mph	max. 3.1 mph
Travel speed 2nd Gear	max. 10.6 mph	max. 9.3 mph
Gradeability	max. 35 %	max. 30 %
Turning radius	30'2"	31'2"

SLEWING DRIVE

Slewing ring	Double slewing ring with inner teeth
Drive	2-stage planetary gear with integrated multi-disk brake
Uppercarriage swing speed	0–7 min ⁻¹ infinitely variable
Slewing lock	Electronically activated

UNDERCARRIAGE

	MHL350 F
Front axle	Planetary drive axle with integrated drum brake, rigidly mounted, max. steering angle 27°
Rear axle	Planetary drive axles with integrated drum brake, with self-aligning bearing and switching oscillating lock
Outrigger	4-point outrigger
Tires	Elastic, solid rubber 8 × 12.00-20

BRAKES

Service brake	Hydraulically operated single-service brake system acting on all four wheel pairs
Parking brake	Electronically-operated disc brake on the driving transmission acting on both axles

HYDRAULIC SYSTEM

Max. flow rate	2 × 87 gpm
Max. operating pressure	4641 / 5221 psi
Hydraulic oil tank	96.7 gal

OPERATOR'S CAB

Cab	Continuously variable elevation system up to a viewing height of 18.4' Soundproof, insulating panoramic windows enabling all-round visibility, windscreen with pull-down sunblind, roof skylight, cab door sliding window, sliding door
Air conditioning	Automatic climate control. Infinitely variable water heating with 8-speed fans, 10 adjustable nozzles, 4 set into the roof lining and 3 defrosting nozzles
Operator's seat	Air-sprung comfort seat with integrated headrest, safety belt, and lower lumbar support, optional seat heating. Allows comfortable working by offering universal adjustment possibilities of the seat position, the seat incline, and the position of the seat cushion in relation to the armrests and joysticks
Monitoring	Ergonomically-arranged, anti-glare controls, multi-functional display, automatic monitoring and storage of deviating operating conditions, (e.g. all hydraulic oil filters, hot/cold hydraulic oil temperature, coolant temperature and charge air temperature, diesel particle filter load), visual and acoustic warning up to the point of shutting feed forward control or reducing engine output. Individual sensor diagnosis using the multi-functional display, rear camera and side camera

	U.S. Tier 4 / EU Stage V	U.S. Tier 3 / EU Stage IIIA *
Noise level	Sound power level (outdoor area) L_{WA} 98.8 dB(A) (measured) as per directive 2000/14/EC L_{WA} 101 dB(A) (guaranteed) as per directive 2000/14/EC Sound power level (inside the cab) as per the standard ISO 6396 L_{PA} 67 dB(A)	Sound power level (outdoor area) L_{WA} 101.3 dB(A) (measured) as per directive 2000/14/EC L_{WA} 102 dB(A) (guaranteed) as per directive 2000/14/EC Sound pressure level (inside the cab) as per the standard ISO 6396 L_{PA} 67 dB(A)
Vibrations	Weighted r.m.s. value of acceleration of upper limbs under 2.5 m/s ² (98 in/s ²) Weighted effective value of acceleration for the seat and feet under 0.5 m/s ² (20 in/s ²)	

Certification as per CE directives

* for low-regulated markets

EQUIPMENT

DIESEL ENGINE

	Standard	Option
Intercooler and coolant radiator	●	
Direct electronic fuel injection / common rail	●	
Advanced automatic idle incl. engine shut-off function	●	
Engine preheating		●
Engine diagnostics interface	●	
Temperature-dependent fan drive	●	

UNDERCARRIAGE

All-wheel drive	●	
Drum brakes	●	
Rear axle oscillating lock	●	
2-speed powershift transmission		●
4-point stabilizers	●	
Dozer blade in addition to 4-point stabilizers		●
Stabilizer cylinders with integrated two-way check valves	●	
Piston rod protection on stabilizer cylinders	●	
Tool box	●	
Special paint (customer paint work)		●
Solid rubber tires (12.00-20) with intermediate rings	●	

UPPERCARRIAGE

Separate cooling system for engine and hydraulic oil cooler	●	
Cooling system with temperature-dependent fan drive	●	
Fan drive reversing function		●
Automatic central lubrication system	●	
Rear view camera	●	
Side view camera	●	
Travel alarm	●	
Electric refuelling pump		●
Lighting protection		●
Special paint (customer paint work)		●

CAB

Hydraulically adjustable cab	●	
Safety glass	●	
Sliding window in cab door	●	
Glass ceiling	●	
Reinforced glass P5A (windscreen and roof panel)		●
Windshield washer system	●	

CAB

	Standard	Option
Roof washer system (roof panel)		●
Air-cushioned operator seat with headrest, seatbelt, and lumbar support	●	
Seat heating		●
Joystick steering	●	
Steering column, height and tilt adjustable		●
Automatic air conditioning system	●	
Independent heating system		●
Multi-function display	●	
Document clip	●	
FOPS Guard		●
Front and FOPS Guard		●
12V transformer		●
Radio USB & Bluetooth (EU & USA)		●
12V socket	●	
Fire extinguisher, dry powder		●
Travel alarm w/ rotating beacon		●

OTHER EQUIPMENT

13 kW DC generator with controls		●
20 kW DC generator with controls		●
Close proximity range limiter for dipper stick	●	
Coolant and hydraulic oil level monitoring system	●	
Filter system for attachments		●
Hose rupture valves for boom cylinder		●
Hose rupture valves for stick cylinder		●
Overload warning device		●
Quick coupling on dipper stick	●	
Dipper stick impact protection		●
Active cyclone prefilter (TOP AIR)		●
Hydraulic oil preheating		●
Lubrication of the grab suspension by central lubrication system	●	
Light packages LED		●
LED front headlights	●	
LED working lights cabin roof front	●	
Boom cylinder damping system (piston accumulator)		●
Fuchs Telematics System, incl. 5 years contract	●	

DIMENSIONS MHL350 F

All dimensions in ft & in

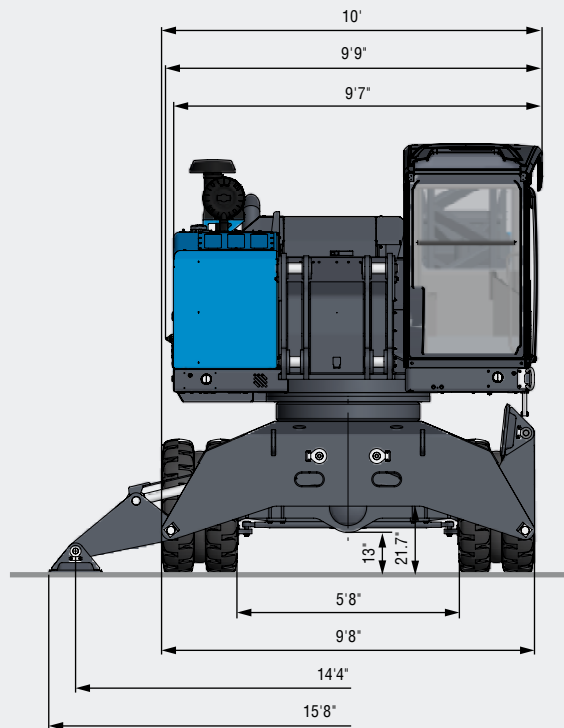
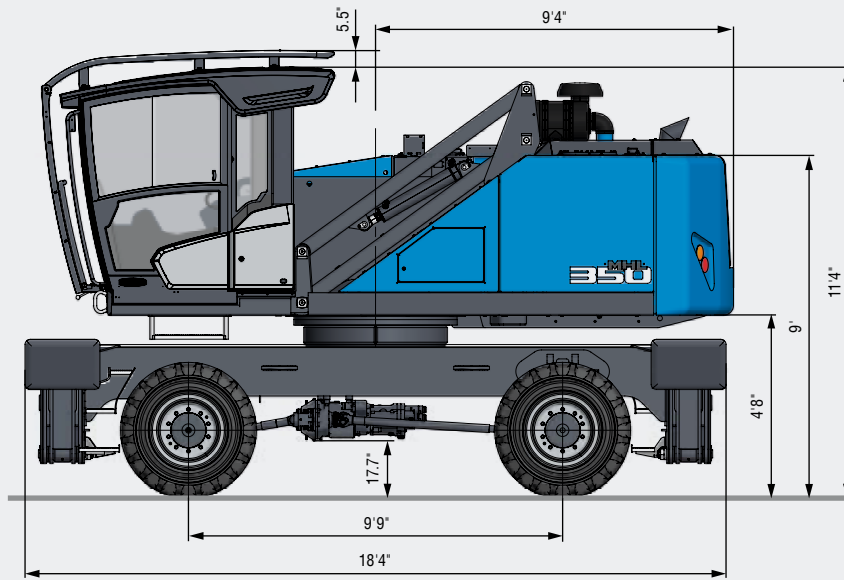

TRANSPORT DIMENSIONS MHL350 F

All dimensions in ft & in

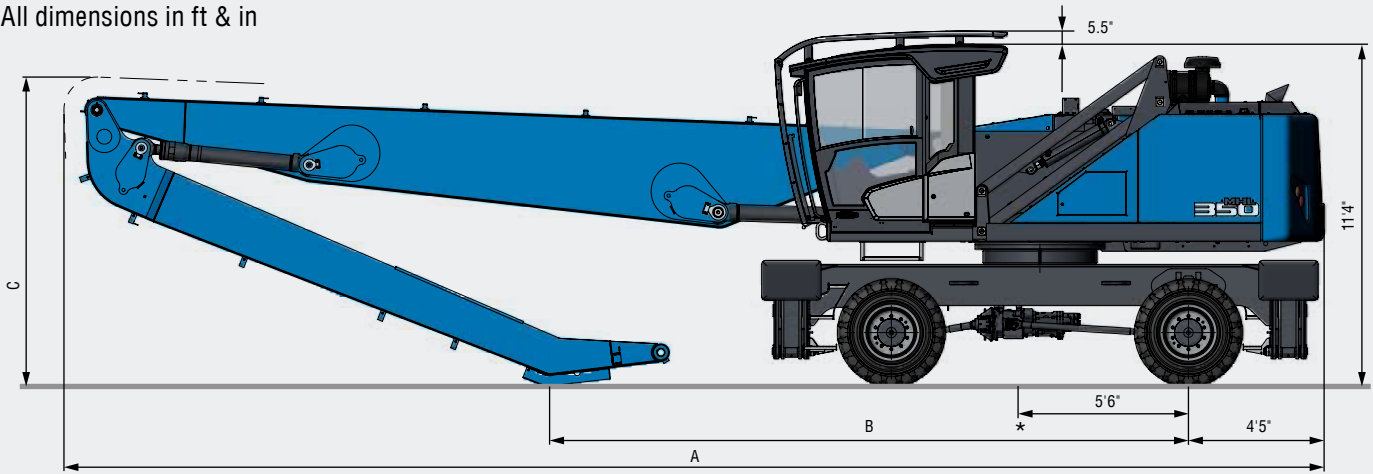

* Average center of gravity in transport position

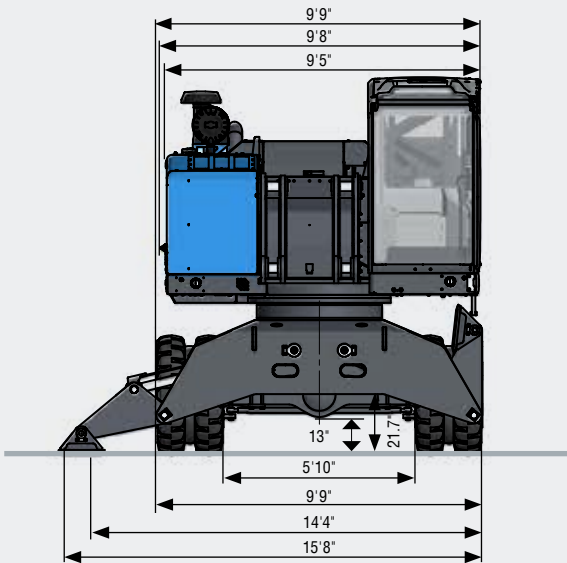

View with roof panel and exterior mirrors removed

Dimensions	Reach 48'3"	Reach 52'5"	Reach 49'2"
A	41'4"	41'7"	41'8"
B	20'1"	19'6"	21'2"
C	10'	11'9"	10'3"

** Multi-purpose stick | Mehrzweckstiel | Balancier à usage multiple | Barra de usos múltiples
Avambraccio universale | Balanceiro multiuso

Reach 48'3" | With multi-purpose stick | All dimensions in ft & in

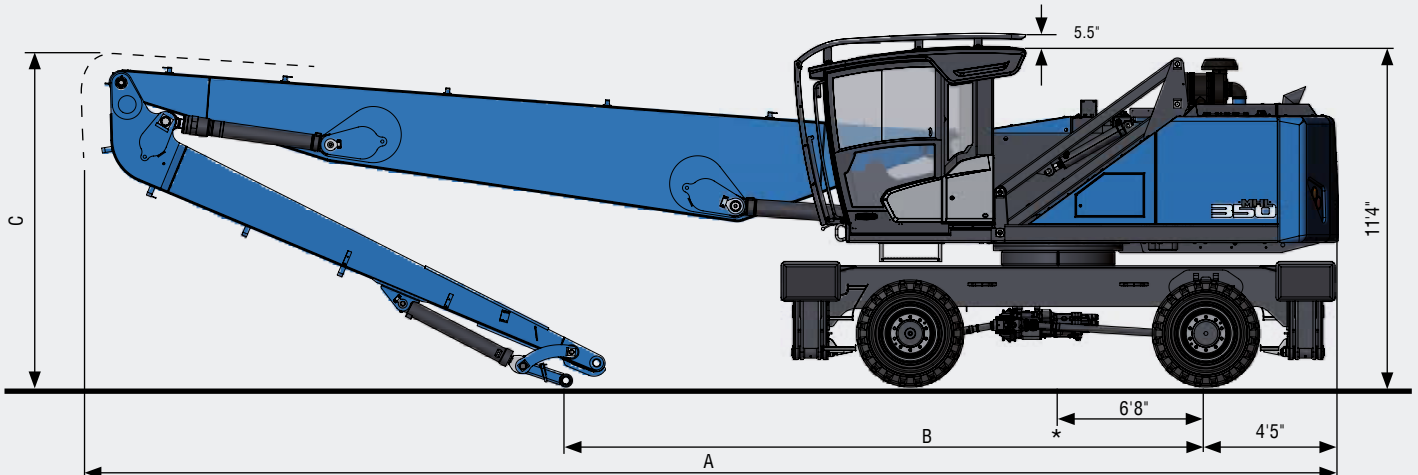

* Average center of gravity in transport position



52'5" WITH DIPPER STICK

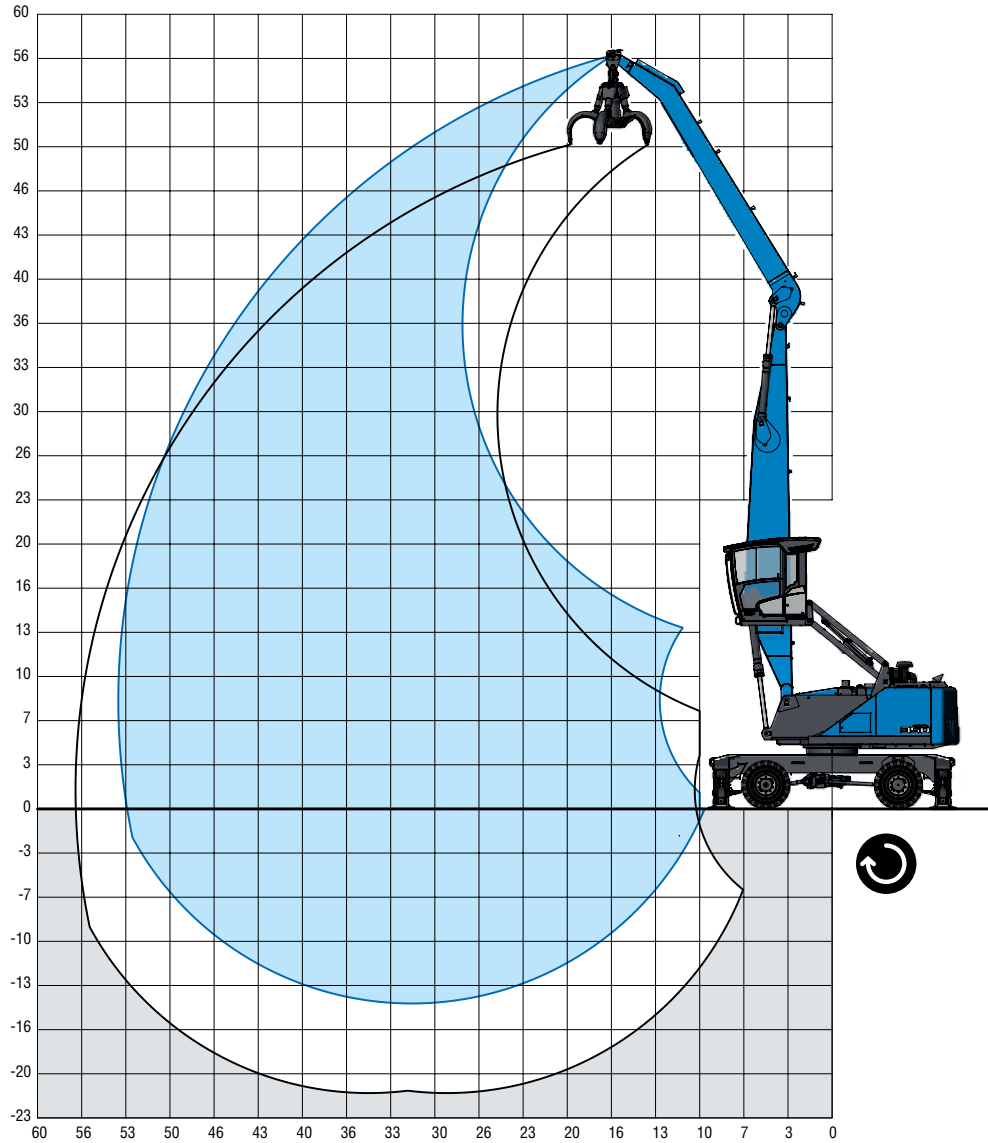

LOADING EQUIPMENT

Boom	27' 8"
Dipper stick	23' 6"
Cactus grab	0.52 yd ³

RECOMMENDED ATTACHMENTS

Recommended attachments upon request

LIFTING CAPACITY

Reach	Undercarriage	Center of rotation								
		15 ft	20 ft	25 ft	30 ft	35 ft	40 ft	45 ft	50 ft	
55 ft			(9,360°)							
			9,360° (9,360°)							
50 ft				(10,310°)	(7,380°)					
				10,310° (10,310°)	7,380° (7,380°)					
45 ft					(10,380°)	(7,720°)				
					10,380° (10,380°)	7,720° (7,720°)				
40 ft					(11,940°)	(9,620°)	(7,230°)			
					11,940° (11,940°)	10,150° (10,150°)	7,230° (7,230°)			
35 ft					(12,670°)	(9,660°)	(7,520°)	(5,830°)		
					13,110° (13,110°)	11,770° (11,770°)	9,570° (9,570°)	5,830° (5,830°)		
30 ft					(12,500°)	(9,550°)	(7,470°)	(5,910°)		
					13,810° (13,810°)	12,410° (12,410°)	11,250° (11,250°)	8,290° (8,290°)		
25 ft				(16,040°)	(12,140°)	(9,310°)	(7,320°)	(5,840°)	(4,670°)	
				16,040° (16,040°)	14,250° (14,250°)	12,660° (12,660°)	11,370° (11,370°)	9,500 (10,100°)	6,330° (6,330°)	
20 ft				(15,680°)	(11,610°)	(8,950°)	(7,080°)	(5,690°)	(4,610°)	
				17,370° (17,370°)	14,890° (14,890°)	13,030° (13,030°)	11,390 (11,560°)	9,350 (10,330°)	7,790 (8,360°)	
15 ft		(22,280°)	(20,840°)	(14,610°)	(10,930°)	(8,500°)	(6,780°)	(5,500°)	(4,510°)	
		22,280° (22,280°)	23,410° (23,410°)	18,730° (18,730°)	15,650° (15,650°)	13,460° (13,460°)	11,080 (11,770°)	9,150 (10,390°)	7,680 (9,120)	
10 ft		(28,740°)	(18,620°)	(13,380°)	(10,180°)	(8,020°)	(6,460°)	(5,300°)	(4,390°)	
		37,430° (37,430°)	26,000° (26,000°)	20,050° (20,050°)	16,370° (16,370°)	13,180 (13,830°)	10,730 (11,930°)	8,930 (10,390°)	7,550 (8,980°)	
5 ft		(11,850°)	(16,590°)	(12,220°)	(9,450°)	(7,540°)	(6,150°)	(5,090°)	(4,270°)	
		11,850° (11,850°)	27,660° (27,660°)	20,850° (20,850°)	15,906 (15,840°)	12,670 (14,040°)	10,400 (11,950°)	8,710 (10,260°)	7,420 (8,700°)	
0 ft		(8,450°)	(15,210°)	(11,320°)	(8,850°)	(7,140°)	(5,880°)	(4,920°)	(4,180°)	
		8,450° (8,450°)	20,370° (20,370°)	19,830 (21,060°)	15,240 (16,860°)	12,240 (13,940°)	10,110 (11,740°)	8,530 (9,920°)	7,320 (8,170°)	
-5 ft		(8,610°)	(14,490°)	(10,740°)	(8,430°)	(6,840°)	(5,680°)	(4,800°)	(4,130°)	
		8,610° (8,610°)	15,840° (15,840°)	19,180 (20,230°)	14,780 (16,280°)	11,920 (13,410°)	9,890 (11,180°)	8,400 (9,250°)	7,250° (7,250°)	
-10 ft			(14,240°)	(10,740°)	(8,200°)	(6,670°)	(5,570°)	(4,750°)		
			15,060° (15,060°)	18,390° (18,390°)	14,530 (14,970°)	11,730 (12,330°)	9,780 (10,130°)	8,100° (8,100°)		
										max. reach 52' 5"
8,2 ft										(3,800)
										4,360° (4,360°)

Important notes regarding the load capacities

The lift capacity values are stated in imperial pounds (lbs). The pump pressure is 5,221 psi. In accordance with ISO 10567 the lift capacity values represents 75% of the static tipping loads or 87% of the hydraulic lifting force (marked °). On solid and level ground the values apply to a swing range of 360°. The (...) values apply in the longitudinal direction of the undercarriage. The values for "not supported" only apply via the steering axle or the locked oscillating axle. The weights of the attached load hoisting equipment (grab, load hook, etc.) must be deducted from the lift capacity values. The working load of the lifting device must be observed. In accordance with the EN 474-5 for object handling application hose rupture valves on the boom and stick cylinders, an overload warning device and the lift capacity table in the cab are required. For object handling application the machine has to be supported on a level ground.

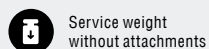



49'2" WITH DIPPER STICK

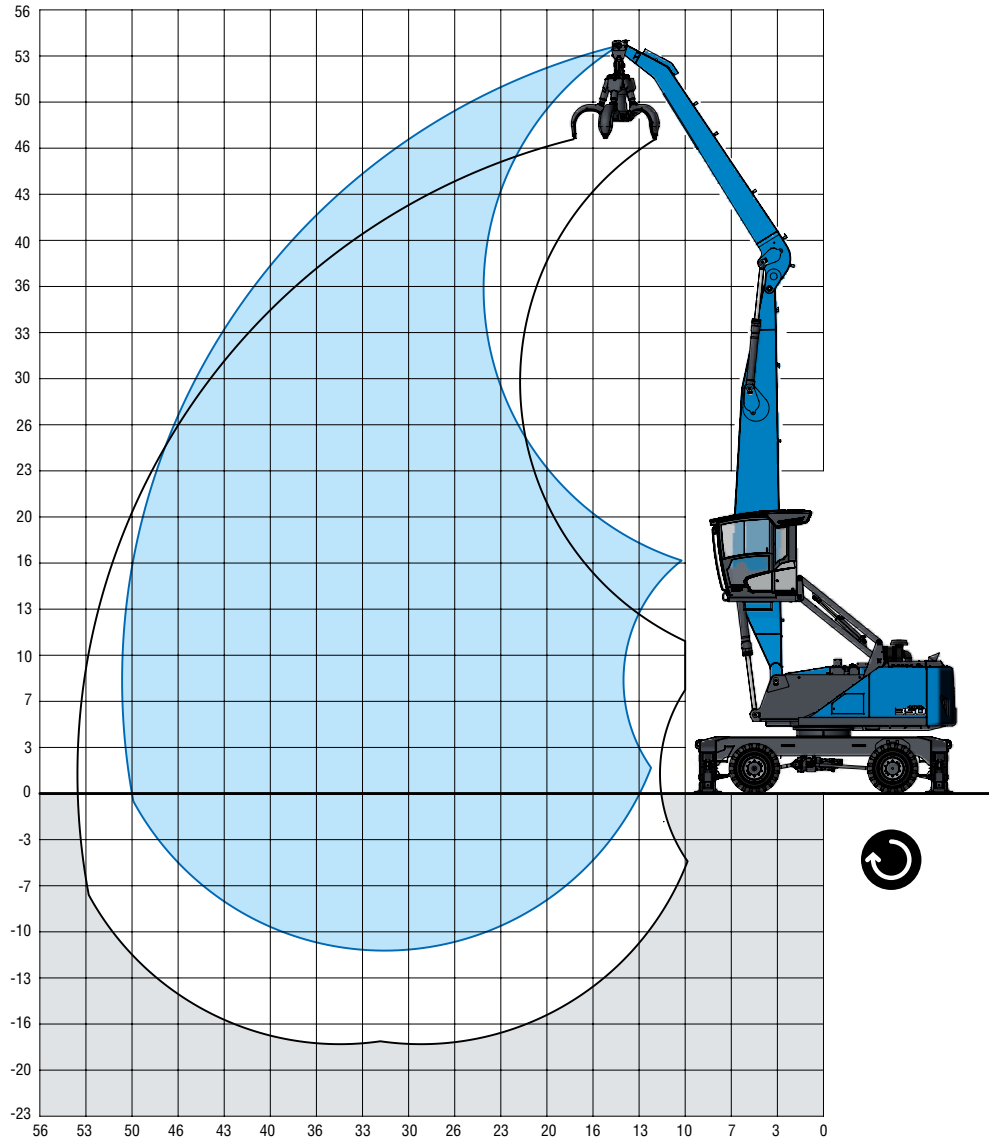































LOADING EQUIPMENT

Boom	27'8"
Dipper stick	20'3"
Cactus grab	0.52 yd ³

RECOMMENDED ATTACHMENTS

Recommended attachments upon request

LIFTING CAPACITY

												
			15 ft	20 ft	25 ft	30 ft	35 ft	40 ft	45 ft	50 ft		
50 ft				(12,110°)	(8,280°)							
			12,110° (12,110°)		8,280° (8,280°)							
45 ft				(12,590°)	(9,590°)							
				12,590° (12,590°)	9,590° (9,590°)							
40 ft				(14,520°)	(12,110)	(9,150)						
				14,520° (14,520°)	12,630° (12,630°)	9,530° (9,530°)						
35 ft				(15,940°)	(12,170)	(9,270)	(7,170)					
				15,940° (15,940°)	14,610° (14,610°)	12,360° (12,360°)	8,520° (8,520°)					
30 ft				(16,290)	(12,020)	(9,200)	(7,190)	(5,650)				
				16,950° (16,950°)	14,780° (14,780°)	13,130° (13,130°)	11,410° (11,410°)	5,900° (5,900°)				
25 ft				(15,770)	(11,670)	(8,980)	(7,080)	(5,650)				
				17,670° (17,670°)	15,200° (15,200°)	13,350° (13,350°)	11,380° (11,870°)	9,060° (9,060°)				
20 ft				(21,400)	(14,960)	(11,160)	(8,660)	(6,880)	(5,550)			
				23,160° (23,160°)	18,740° (18,740°)	15,800° (15,800°)	13,670° (13,670°)	11,170° (12,010°)	9,190° (10,600°)			
15 ft			(30,660)	(19,530)	(13,910)	(10,520)	(8,250)	(6,630)	(5,140)	(4,440)		
			36,010° (36,010°)	25,560° (25,560°)	19,980° (19,980°)	16,460° (16,460°)	13,430° (14,000°)	10,900° (12,140°)	9,030° (10,580°)	6,450° (6,450°)		
10 ft			(14,190°)	(17,470)	(12,790)	(9,850)	(7,830)	(6,360)	(5,240)	(4,370)		
			14,190° (14,190°)	27,610° (27,610°)	21,010° (21,010°)	16,320° (16,990°)	12,970° (14,240°)	10,610° (12,180°)	8,860° (10,460°)	7,520° (7,520°)		
5 ft			(15,840)	(11,820)	(9,240)	(7,430)	(6,100)	(5,090)	(4,310)			
			22,860° (22,860°)	20,380° (21,430°)	15,650° (17,180°)	12,540° (14,250°)	10,340° (12,030°)	8,700° (10,170°)	7,460° (7,460°)			
0 ft			(14,930)	(11,150)	(8,770)	(7,120)	(5,900)	(4,970)	(4,280)			
			15,510° (15,510°)	19,610° (20,930°)	15,130° (16,830°)	12,200° (13,880°)	10,120° (11,590°)	8,580° (9,580°)	6,720° (6,720°)			
-5 ft			(14,450°)	(10,780)	(8,480)	(6,910)	(5,770)	(4,910)				
			14,450° (14,450°)	19,210° (19,210°)	14,820° (15,780°)	11,970° (13,000°)	9,980° (10,710°)	8,510° (8,510°)				
-10 ft				(10,680)	(8,370)	(6,830)						
				16,810° (16,810°)	13,930° (13,930°)	11,460° (11,460°)						
												max. reach 49'2"
8,2 ft											(4,240)	
											5,430° (5,430°)	

Important notes regarding the load capacities

The lift capacity values are stated in imperial pounds (lbs). The pump pressure is 5,221 psi. In accordance with ISO 10567 the lift capacity values represents 75% of the static tipping loads or 87% of the hydraulic lifting force (marked °). On solid and level ground the values apply to a swing range of 360°. The (...) values apply in the longitudinal direction of the undercarriage. The values for "not supported" only apply via the steering axle or the locked oscillating axle. The weights of the attached load hoisting equipment (grab, load hook, etc.) must be deducted from the lift capacity values. The working load of the lifting device must be observed. In accordance with the EN 474-5 for object handling application hose rupture valves on the boom and stick cylinders, an overload warning device and the lift capacity table in the cab are required. For object handling application the machine has to be supported on a level ground.



Reach



Engine power



Service weight without attachments



Center of rotation



Height



Undercarriage



4-point supported



48'3" WITH MULTI-PURPOSE STICK

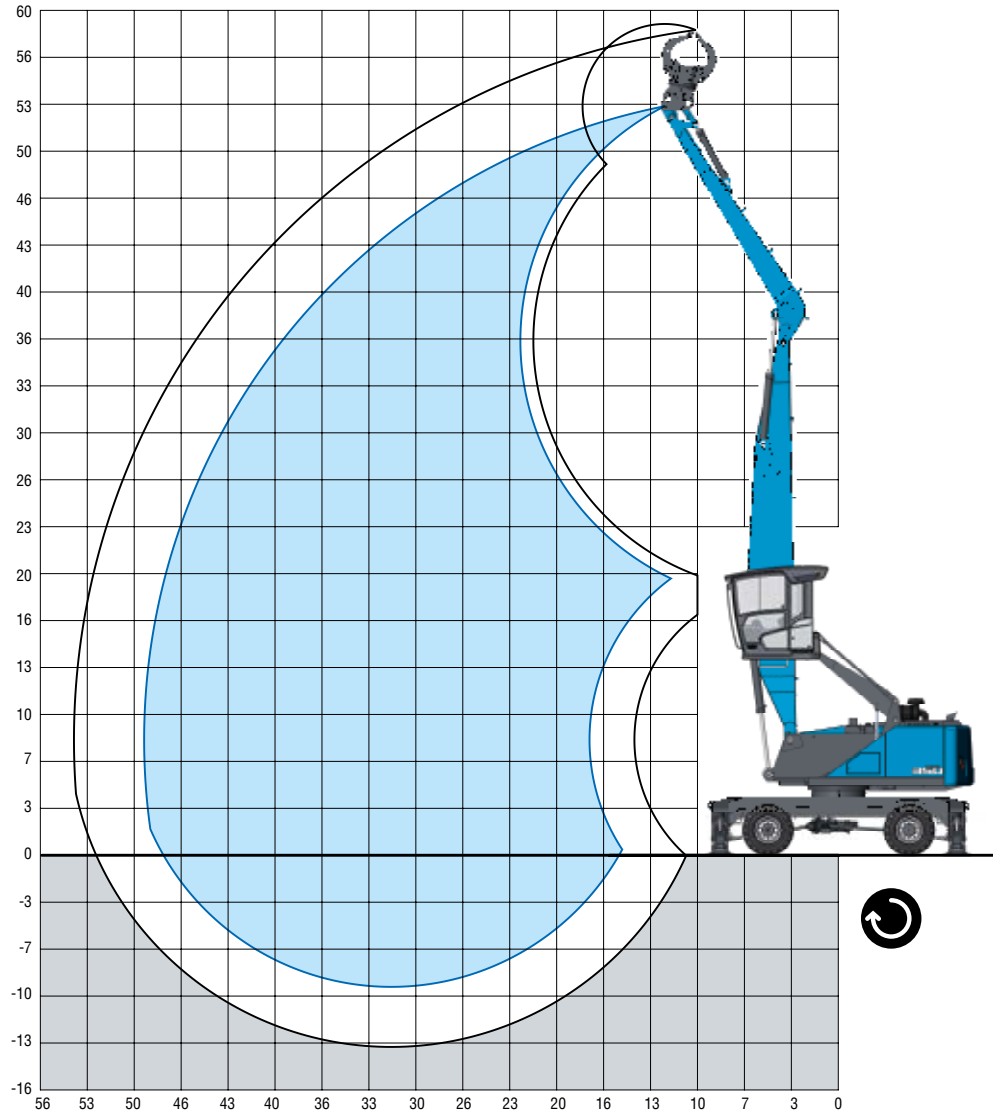

[ft]

















LOADING EQUIPMENT

Boom	27'8"
Multi-purpose stick	18'4"
Sorting grab	0.58 yd ³

RECOMMENDED ATTACHMENTS

Recommended attachments upon request

LIFTING CAPACITY

								
		15 ft	20 ft	25 ft	30 ft	35 ft	40 ft	45 ft
50 ft			10,100° 10,100° (10,100°)					
45 ft				(11,900°) 11,900° (11,900°)				
40 ft				(14,800°) 14,800° (14,800°)	(11,200) 12,100° (12,100°)	(7,500°) 7,500° (7,500°)		
35 ft				(15,700) 16,800° (16,800°)	(11,500) 14,600° (14,600°)	(8,600) 11,900° (11,900°)	(5,800°) 5,800° (5,800°)	
30 ft				(15,400) 17,200° (17,200°)	(11,200) 14,800° (14,800°)	(8,600) 13,000° (13,000°)	(6,600) 10,400° (10,400°)	
25 ft			(21,600°) 21,800° (21,800°)	(15,000) 17,900° (17,900°)	(11,000) 15,200° (15,200°)	(8,400) 13,000° (13,000°)	(6,400) 10,800° (11,500°)	(5,100) 6,600° (6,600°)
20 ft		(30,200°) 30,200° (30,200°)	(20,300) 23,800° (23,800°)	(14,100) 18,700° (18,700°)	(10,400) 15,700° (15,700°)	(7,900) 13,200 (13,400°)	(6,400) 10,600 (11,700°)	(5,100) 8,600 (9,700°)
15 ft		(28,200) 37,700° (37,700°)	(18,300) 26,000° (26,000°)	(13,000) 19,800° (19,800°)	(9,700) 16,300° (16,300°)	(7,700) 12,800 (13,700°)	(6,200) 10,400 (11,700°)	(4,900) 8,600 (9,900°)
10 ft			(16,300) 27,600° (27,600°)	(11,900) 20,500 (20,700°)	(9,300) 15,700 (16,500°)	(7,300) 12,300 (13,700°)	(5,800) 10,100 (11,700°)	(4,900) 8,400 (9,700°)
5 ft			(15,000) 16,800° (16,800°)	(11,000) 19,600 (20,700°)	(8,600) 15,000 (16,500°)	(6,800) 11,900 (13,700°)	(5,500) 9,900 (11,200°)	(4,600) 8,200 (9,300°)
0 ft			(13,400°) 13,400° (13,400°)	(10,600) 19,000 (19,800°)	(8,200) 14,600 (15,900°)	(6,600) 11,700 (13,000°)	(5,500) 9,700 (10,800°)	(4,600) 8,200 (8,600°)
-5 ft			(13,700°) 13,700° (13,700°)	(10,400) 17,900° (17,900°)	(7,900) 14,300 (14,600°)	(6,400) 11,500 (11,900°)	(5,300) 9,500° (9,700°)	
								max. reach 48'3"
8,2 ft								(4,000) 5,800° (5,800°)

i Important notes regarding the load capacities

The lift capacity values are stated in imperial pounds (lbs). The pump pressure is 5,221 psi. In accordance with ISO 10567 the lift capacity values represents 75% of the static tipping loads or 87% of the hydraulic lifting force (marked °). On solid and level ground the values apply to a swing range of 360°. The (...) values apply in the longitudinal direction of the undercarriage. The values for "not supported" only apply via the steering axle or the locked oscillating axle. The weights of the attached load hoisting equipment (grab, load hock, etc.) must be deducted from the lift capacity values. The working load of the lifting devise must be observed. In accordance with the EN 474-5 for object handling application hose rupture valves on the boom and stick cylinders, an overload warning device and the lift capacity table in the cab are required. For object handling application the machine has to be supported on a level ground.

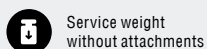

TRANSPORT DIMENSIONS MHL350 FQC F

All dimensions in ft and in

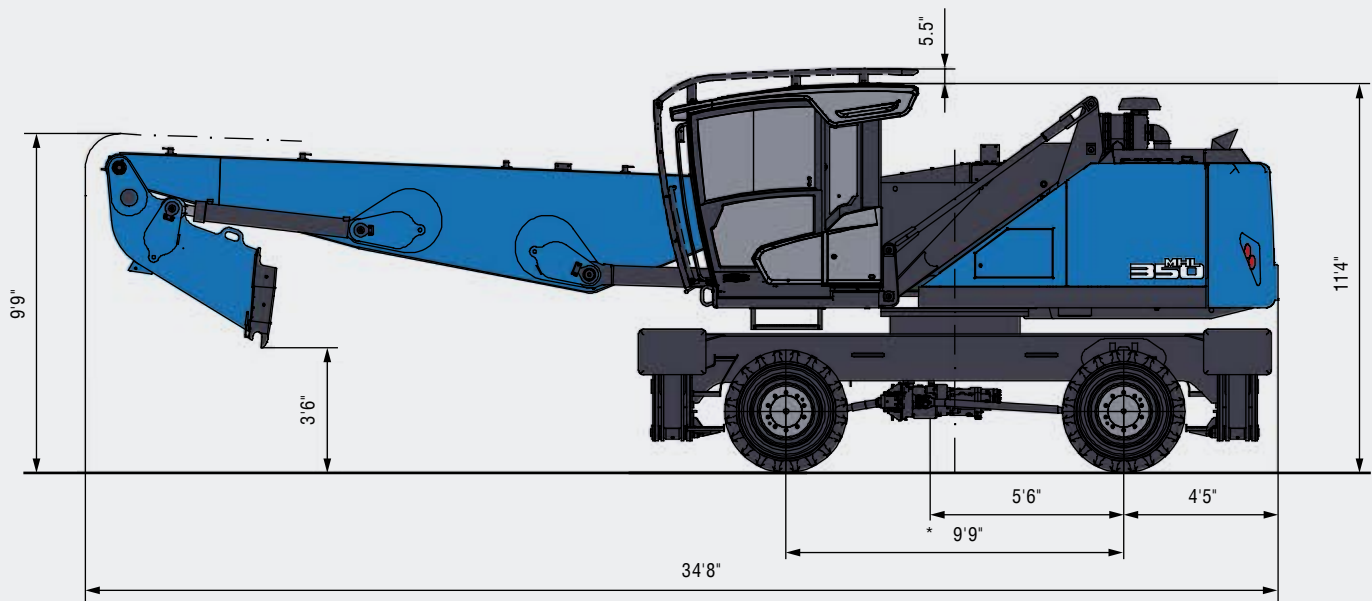

* Average center of gravity in transport position

TRANSPORT DIMENSIONS MHL350 FQC F

All dimensions in ft and in

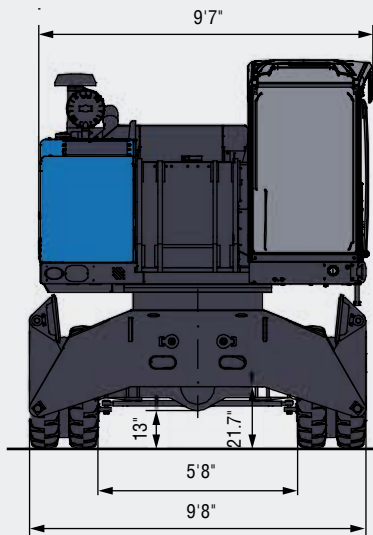



42'8" WITH DIPPER STICK

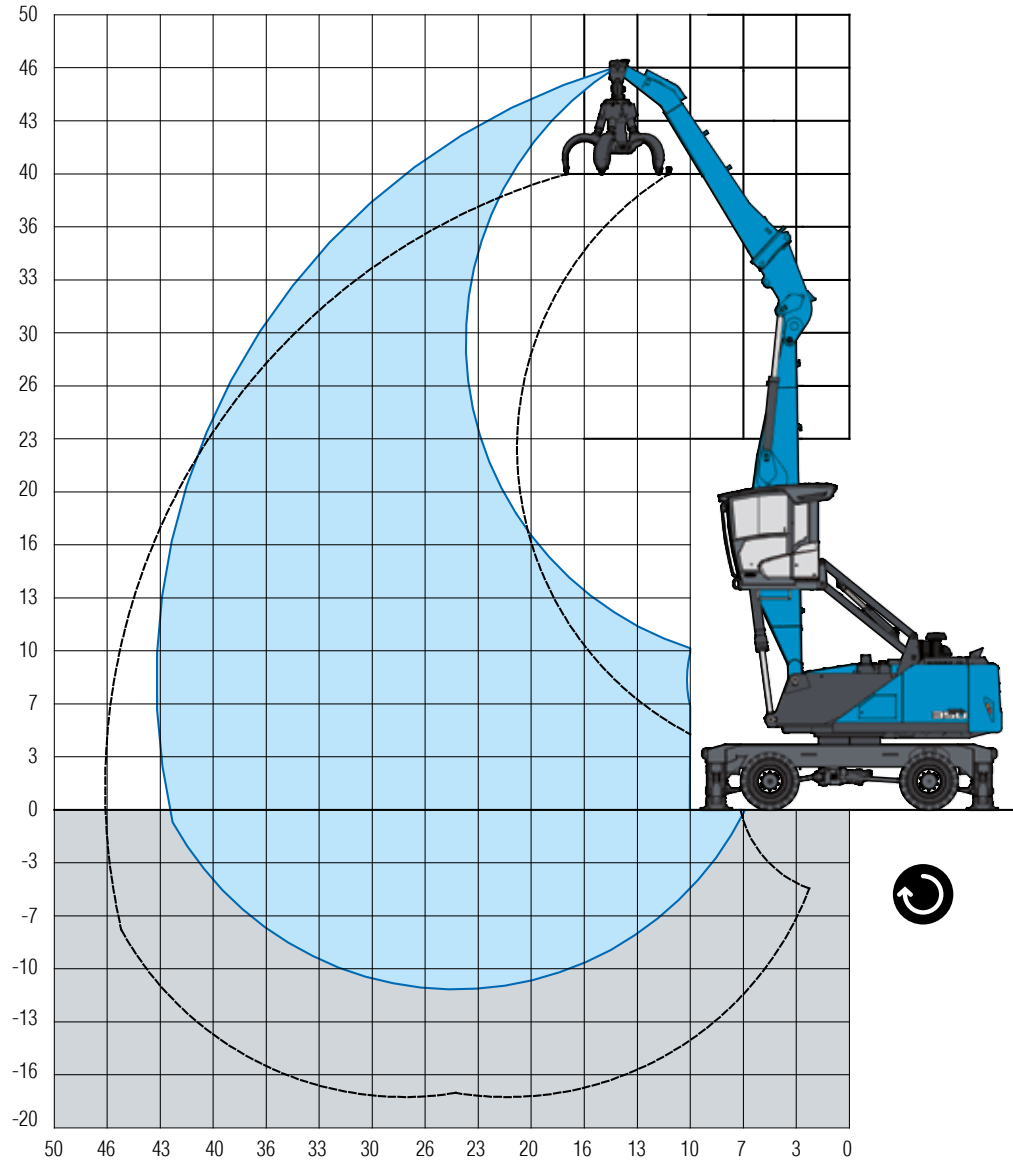















LOADING EQUIPMENT

Boom	20' 9"
Dipper stick	20'
Cactus grab	0.52 yd ³

RECOMMENDED ATTACHMENTS

Recommended attachments upon request

LIFTING CAPACITY

								
		10 ft	15 ft	20 ft	25 ft	30 ft	35 ft	40 ft
40 ft					(9,900°) 9,900° (9,900°)			
35 ft					(13,100°) 13,100° (13,100°)	(9,700°) 9,700° (9,700°)		
30 ft					(14,800°) 14,800° (14,800°)	(11,600°) 12,500° (12,500°)	(8,300°) 8,300° (8,300°)	
25 ft					(15,800°) 16,400° (16,400°)	(11,500°) 14,600° (14,600°)	(8,600°) 11,200° (11,200°)	
20 ft					(15,400°) 17,300° (17,300°)	(11,200°) 15,300° (15,300°)	(8,400°) 13,500° (13,500°)	(6,500°) 7,900° (7,900°)
15 ft				(21,200°) 22,100° (22,100°)	(14,600°) 18,600° (18,600°)	(10,700°) 16,000° (16,000°)	(8,100°) 13,400 (13,900°)	(6,300°) 10,000° (10,000°)
10 ft		(30,800°) 30,800° (30,800°)	(31,300°) 34,400° (34,400°)	(19,400°) 25,200° (25,200°)	(13,600°) 20,100° (20,100°)	(10,100°) 16,700 (16,700°)	(7,800°) 13,000 (14,200°)	(6,200°) 10,400 (11,600°)
5 ft		(12,200°) 12,200° (12,200°)	(27,200°) 40,300° (40,300°)	(17,600°) 27,700° (27,700°)	(12,600°) 21,200° (21,200°)	(9,500°) 16,000 (17,200°)	(7,400°) 12,600 (14,200°)	(6,000°) 10,200 (11,700°)
0 ft		(8,600°) 8,600° (8,600°)	(23,600°) 23,600° (23,600°)	(16,200°) 28,600° (28,600°)	(11,800°) 20,400 (21,600°)	(9,000°) 15,500 (17,100°)	(7,100°) 12,300 (13,800°)	(5,800°) 10,100 (10,900°)
-5 ft			(18,500°) 18,500° (18,500°)	(15,400°) 27,300° (27,300°)	(11,200°) 19,800 (20,600°)	(8,700°) 15,100 (16,200°)	(7,000°) 12,100 (12,700°)	
-10 ft				(15,100°) 23,500° (23,500°)	(11,000°) 18,000° (18,000°)	(8,600°) 13,900° (13,900°)		
								max. reach 42'8"
8 ft								(4,800°) 4,800° (4,800°)

i Important notes regarding the load capacities

The lift capacity values are stated in imperial pounds (lbs). The pump pressure is 5,221 psi. In accordance with ISO 10567 the lift capacity values represents 75% of the static tipping loads or 87% of the hydraulic lifting force (marked °). On solid and level ground the values apply to a swing range of 360°. The (...) values apply in the longitudinal direction of the undercarriage. The values for "not supported" only apply via the steering axle or the locked oscillating axle. The weights of the attached load hoisting equipment (grab, load hook, etc.) must be deducted from the lift capacity values. The working load of the lifting device must be observed. In accordance with the EN 474-5 for object handling application hose rupture valves on the boom and stick cylinders, an overload warning device and the lift capacity table in the cab are required. For object handling application the machine has to be supported on a level ground.

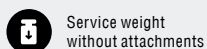



42' WITH MULTI-PURPOSE STICK

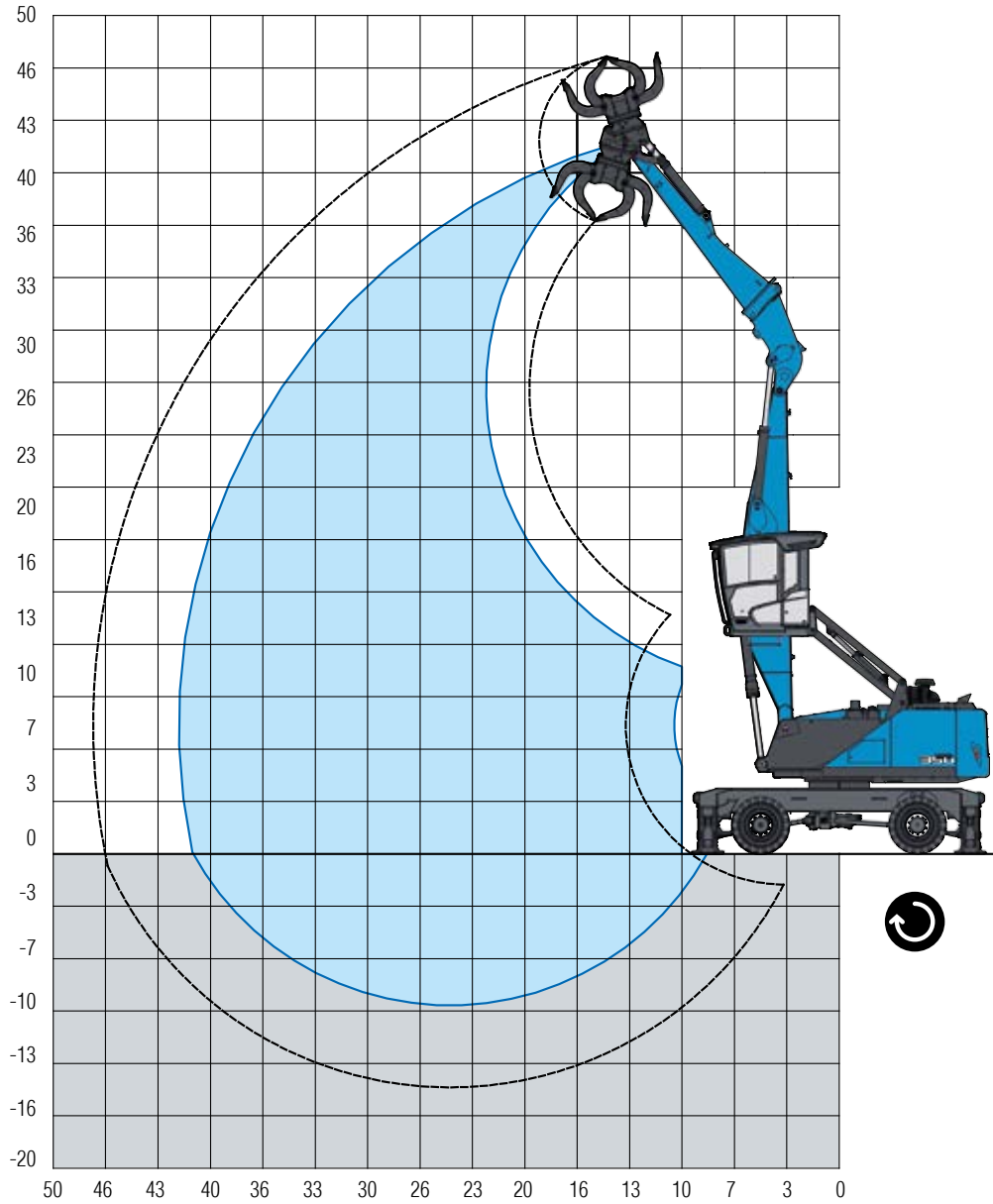















LOADING EQUIPMENT

Boom	20'9"
Dipper stick	18'3"
Cactus grab	0.52 yd ³

RECOMMENDED ATTACHMENTS

Recommended attachments upon request

LIFTING CAPACITY

								
		10 ft	15 ft	20 ft	25 ft	30 ft	35 ft	40 ft
45 ft			(14,100°) 14,100° (14,100°)					
40 ft				(14,300°) 14,300° (14,300°)	(9,500°) 9,500° (9,500°)			
35 ft					(13,600°) 13,600° (13,600°)	(9,300°) 9,300° (9,300°)		
30 ft					(14,500) 15,400° (15,400°)	(10,300) 12,800° (12,800°)	(7,200°) 7,200° (7,200°)	
25 ft					(14,400) 16,000° (16,000°)	(10,200) 14,300° (14,300°)	(7,500) 11,100° (11,100°)	
20 ft				(18,200°) 18,200° (18,200°)	(13,900) 16,800° (16,800°)	(9,900) 14,600° (14,600°)	(7,300) 12,500 (12,900°)	(5,500) 6,500° (6,500°)
15 ft				(19,500) 22,200° (22,200°)	(13,200) 18,100° (18,100°)	(9,500°) 15,300° (15,300°)	(7,100) 12,300 (13,100°)	(5,400) 9,200 (9,200°)
10 ft			(29,100) 35,800° (35,800°)	(18,000) 25,300° (25,300°)	(12,400) 19,600° (19,600°)	(9,100) 15,600 (15,900°)	(6,800) 12,000 (13,300°)	(5,300) 9,500 (10,900°)
5 ft			(26,000) 34,300° (34,300°)	(16,600) 27,600° (27,600°)	(11,600) 20,300 (20,700°)	(8,600) 15,100 (16,300°)	(6,600) 11,700 (13,200°)	(5,100) 9,400 (10,400°)
0 ft		(4,400°) 4,400° (4,400°)	(15,600°) 15,600° (15,600°)	(15,500) 28,000° (28,000°)	(11,000) 19,600 (20,700°)	(8,300) 14,700 (16,100°)	(6,400) 11,500 (12,600°)	(5,100) 9,200° (9,200°)
-5 ft			(14,900°) 14,900° (14,900°)	(15,100) 26,000° (26,000°)	(10,700) 19,200 (19,400°)	(8,000) 14,400 (14,800°)	(6,300) 11,000° (11,000°)	
								max. reach 42'
8 ft								(3,700°) 3,700° (3,700°)

Important notes regarding the load capacities

The lift capacity values are stated in imperial pounds (lbs). The pump pressure is 5,220 psi. In accordance with ISO 10567 the lift capacity values represents 75% of the static tipping loads or 87% of the hydraulic lifting force (marked °). On solid and level ground the values apply to a swing range of 360°. The (...) values apply in the longitudinal direction of the undercarriage. The values for "not supported" only apply via the steering axle or the locked oscillating axle. The weights of the attached load hoisting equipment (grab, load hook, etc.) must be deducted from the lift capacity values. The working load of the lifting device must be observed. In accordance with the EN 474-5 for object handling application hose rupture valves on the boom and stick cylinders, an overload warning device and the lift capacity table in the cab are required. For object handling application the machine has to be supported on a level ground.



Reach



Engine power



Service weight without attachments



Center of rotation



Height



Undercarriage



4-point supported



36' WITH SCRAP SHEARS

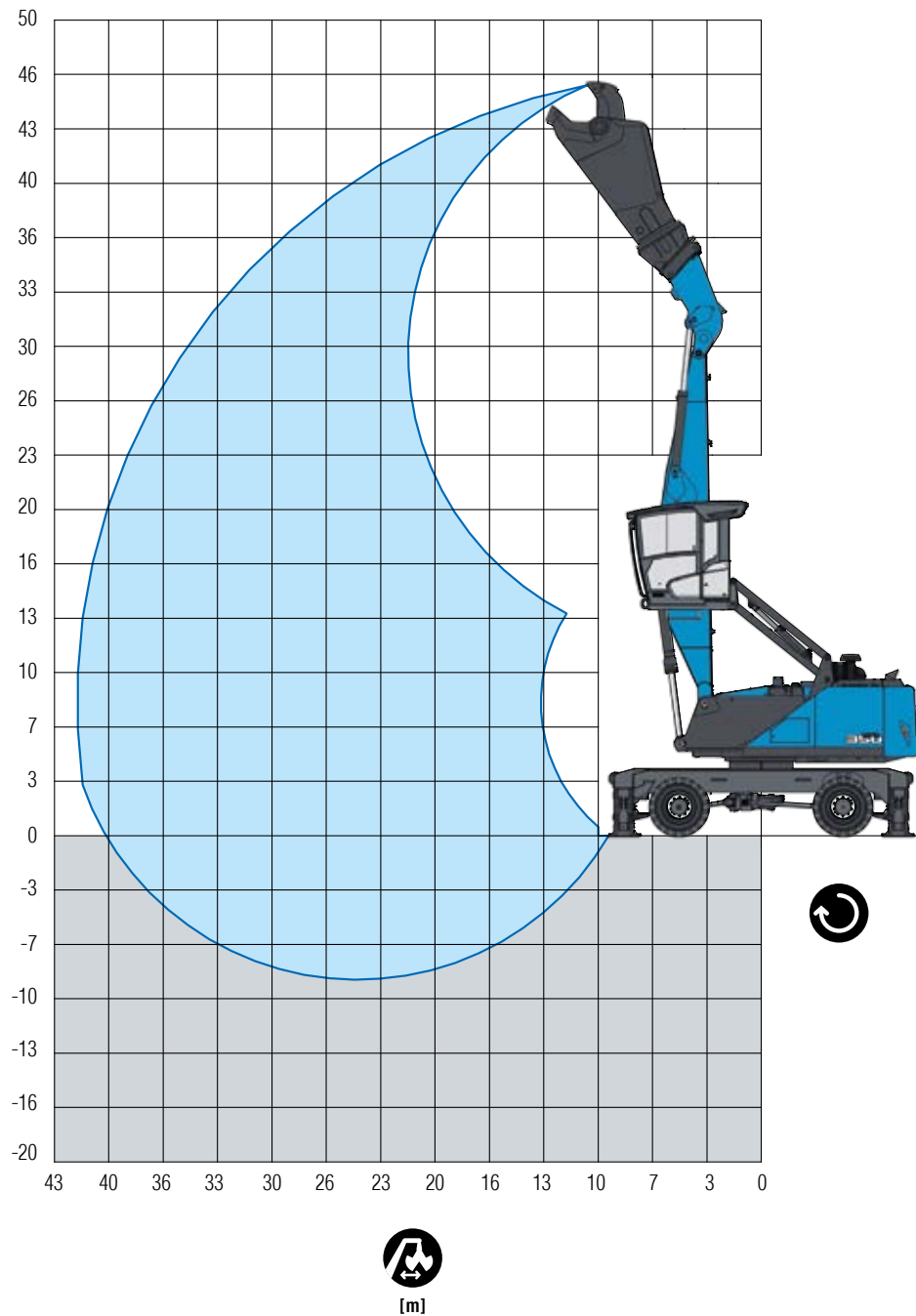

LOADING EQUIPMENT

Boom	21'
Scrap shears with Fuchs QuickConnect	14'5"

MODULAR SYSTEM

ATTACHMENTS

Cactus grab



Sorting grapple



Clamshell grab

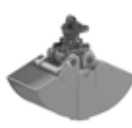

Furthermore: Timber grapple, Scrap shears, Magnet plate, Load hook

LOADING EQUIPMENT

Loading equipment straight



Loading equipment with multipurpose stick



ENGINE

Diesel engine



Electric motor



UPPERCARRIAGE MHL350



Cab system hydraulically adjustable



OPTIONS

Cable reel



Cable drum



UNDERCARRIAGE

Pylon

up to max. 2'6"



Pylon

up to max. 4'6"



Pylon

up to max. 2'6"



Pylon

up to max. 12'1"



Pylon

up to max. 12'1"



Mobile: Standard-undercarriage



Mobile special: XL-undercarriage



Crawler: Standard-undercarriage



Crawler: XL-undercarriage



Pedestal undercarriage



FUCHS[®]
A TEREX BRAND

WORKS FOR YOU.™

www.terex-fuchs.com

May 2021. Product specifications and prices are subject to change without notice or obligation. The photographs and/or drawings in this document are for illustrative purposes only. Refer to the appropriate Operator's Manual for instructions on the proper use of this equipment. Failure to follow the appropriate Operator's Manual when using our equipment or to otherwise act irresponsibly may result in serious injury or death. The only warranty applicable to our equipment is the standard written warranty applicable to the particular product and sale and Terex makes no other warranty, express or implied. © Terex Corporation 2021 - Terex, the Terex Crown design, Fuchs and Works For You are trademarks of Terex Corporation or its subsidiaries.

Terex[®] Deutschland GmbH | Industriestraße 3 | 76669 Bad Schönborn | Germany | Fon: +49 (0) 7253 84-0 | Fax: +49 (0) 7253 84-102 | info@terex-fuchs.com

